



To continue its program of quality and design improvement, the manufacturer reserves the right to change specifications, design or prices without notice and without incurring obligation.

ILLUSTRATED PARTS LIST

LAWN ROLLER

Model Number 15575E1
 Effective Date 5-15-73
 Form Number 19657P1

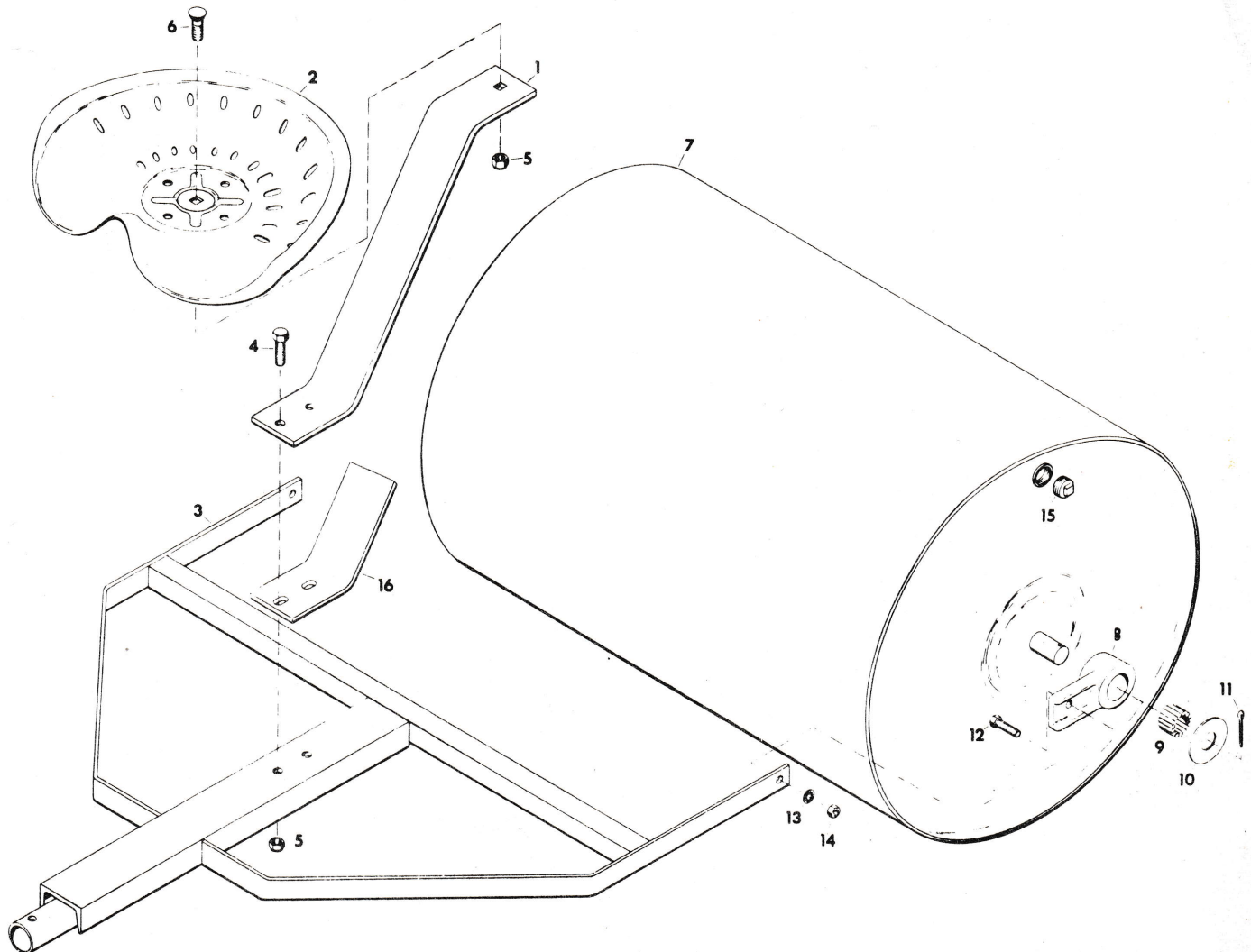

<u>ITEM NO.</u>	<u>PART NO.</u>	<u>DESCRIPTION</u>
1	12520P1	Seat Spring
2	12521P1	Seat
3	13668A1	Frame Water Roller
4	180179	1/2-13 x 1-3/4 Hex Hd. Bolt Gr. 5 Cad
5	435507	1/2-13 Washer Insert Locknut
6	126485	1/2-13 x 1-1/4 Carriage Bolt Gr. 5 Cad
7	13667A1	Drum Water Roller
8	12948A1	Bearing and Bracket Assembly
9	10373P1	Bearing Rollers
10	446275	1.062 x 2.250 x .165 Flatwasher
11	103422	1/4 x 2 Cotter Pin
12	133167	3/8-16 x 1-1/4 Rd Hd Machine Screw
13	138542	3/8 Internal Tooth Lockwasher
14	120374	3/8-16 Square Nut
15	143937	1" Sq. Hd. Pipe Plug Cad
16	17839P1	Reinforcement Plate